



# Hand Sprayer Calibration Steps Worksheet

*Robert E. Wolf, Extension Specialist, Biological and Agricultural Engineering, Kansas State University*

The key to handgun calibration is knowing the volume you are spraying over a given time period. If you know the area you cover at a set pace, you can calibrate your handgun applications.

Here is a simple formula:

1 acre = 43,560 square feet

1 gallon = 128 ounces

$\frac{1}{128}$  acre  $\approx$  340 square feet

18.5 feet by 18.5 feet =  $\frac{1}{128}$  acre

1. Mark off an area 18.5 feet by 18.5 feet; flag the corners.
2. With a stopwatch, time how long it takes you to spray the area, using a proper technique to achieve uniform coverage, at your normal walking pace. This can be done with a handgun on an ATV, a backpack sprayer, or a pump-up sprayer.
3. Now, spray into a bucket or measuring cup (item 8, page 2) at the same pressure for the same time you recorded in step 2 and record that volume in ounces.
4. The rate per acre is 1 gallon for each captured ounce.

**Example:** It takes 20 seconds to make three passes that cover the marked area. Spray into a bucket for 20 seconds with the sprayer and then pour the fluid into a measuring cup marked in ounces. In this example, there are 31 ounces of water. The 31 ounces covers approximately 340 square feet. Multiplying 340 times 128 equals 43,520 square feet (about 1 acre). Then, 31 ounces times 128 equals 3,968 ounces. Dividing 3,968 by 128 ounces equals 31 gallons per acre.

**Table 1.** Sample spot application rates

Sprayer size	1 gallon	3 gallons	5 gallons	10 gallons	14 gallons	25 gallons	100 gallons
2% solution	16 teaspoons	8 fluid ounces	12.8 fluid ounces	25.6 fluid ounces	36 fluid ounces	4 pints	8 quarts

For individual plant treatments on brush, the common terminology used is “spray to wet,” but on some labels “spray to run-off” is referenced. **These are not the same.** Spray to wet means to just get coverage on all the foliage. Continuing to spray will achieve spray to run-off, or dripping from the leaves.

For spot applications of brush products, a general rule is to apply 75 to 100 gallons per acre on a foliar spray. The same timed procedure described above can be used to calibrate the sprayer.

A good method for determining the exact spray technique and nozzle height for the most uniform coverage is to spray on a warm, dry surface, such as a road or parking lot, and observe the drying rate. A uniform drying rate indicates uniform coverage, whereas streaking indicates uneven coverage. Adjust the nozzle height or application technique to eliminate excess streaking.

Many labels will have spot application rates and recommendations for noncrop uses. In some cases, crop chemicals have small area rates listed. In other cases, you have to do the math to figure your correct mixtures. See Table 1 for some examples.

## Using spray management valves to maintain a uniform pressure and constant flow rate

Calibration and precise application with hand-held spray equipment is difficult to achieve because pressures vary during application and from operator to operator. High pressures will relate to higher flows with more driftable droplets. Lower pressures will result in lower flows and larger drift-resistant droplets that may not achieve the desired coverage. A pressure gauge on the spray wand is the best option for monitoring the output pressure. Also, the

addition of a spray management valve (SMV) to a compression or backpack sprayer will help maintain a constant pressure while spraying. Thus, spray rates and patterns will be more consistent, drift potential is reduced, calibration is easier, and the valve will provide an instant on and off with no dripping. Spray management valves are available in four preset pressure ranges: 14.5, 21.0, 29.0, and 43.5 pounds per square inch (psi). Find information about purchasing a spray management valve at [www.hdhudson.com/green-garde.html](http://www.hdhudson.com/green-garde.html). The cost is minimal.

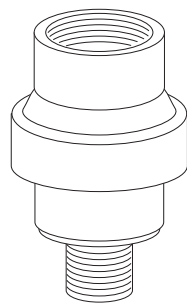

**Spray management valve (SMV)**

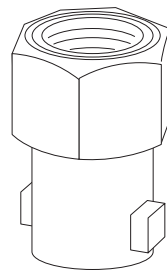

1

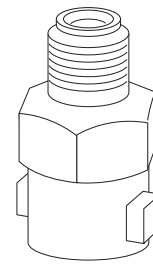

2

**Female (1) and male (2) adapters without diaphragm**

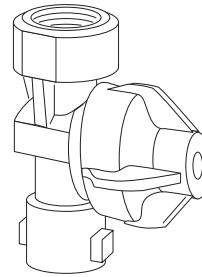

3

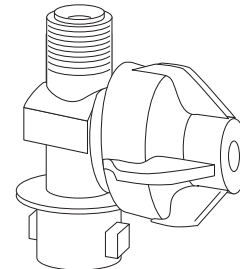

4

**Female (3) and male (4) adapters with diaphragm**

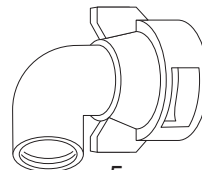

5

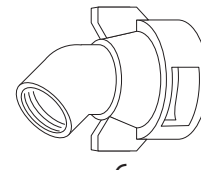

6

**90-degree (5) and 45-degree (6) elbow adapters**

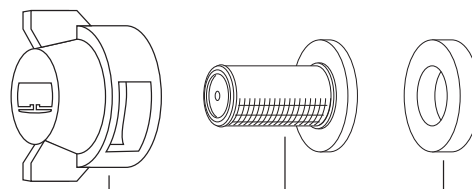

Quick cap, screen, and seat gasket

7

**Quick cap, screen, and seat gasket set (7)**

**Hand sprayer with pressure gauge, pressure valve, and nozzle options**

**Converting common hand sprayer adjustable nozzle systems to flat-spray nozzle types**

For certain applications, it may be advantageous to adapt a common hand sprayer wand with an adjustable nozzle (straight stream to broadcast) so it can be equipped with a nozzle type that can provide more uniform coverage with less drift potential. By changing the system to a flat-spray nozzle type, a more uniform pattern can be achieved. It also is possible to use nozzle designs that can reduce drift and provide more efficient applications by reducing off-target movement of the spray.

Converting a handheld spray wand to use flat-spray and drift-reducing nozzle types is a simple process. First, remove the adjustable nozzle. If you

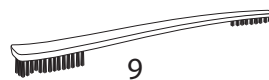
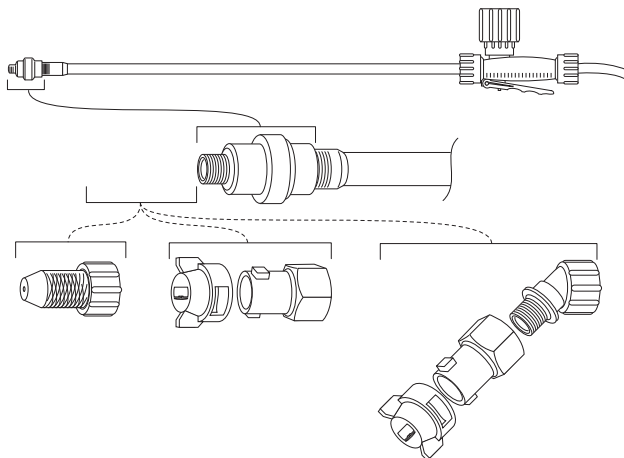

9



8

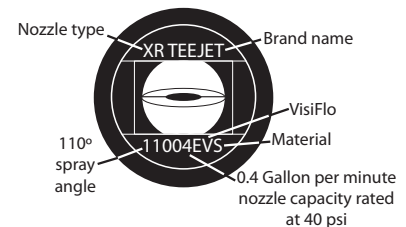

10

**Calibration cup (8) and nozzle cleaning brush (9); Flat-fan nozzle nomenclature (10)**

are using an SMV, add an adapter designed for connecting quick-attach nozzle (item 7) types (items 1 or 2), or use item 3 or 4 if no SMV is in use.

Items 3 and 4 are equipped with diaphragm check valves that prevent dripping when the hand wand is shut off. They do not manage the spray pressure like the SMV. A 90- or 45-degree elbow may be useful for positioning the nozzle (item 5 or 6). See hand wand adapter options pictured earlier.

Adapters and quick attach nozzles shown are available from spray equipment supply outlets. Refer to websites listed in Table 2.

### Nozzle types with more uniform patterns and drift reduction potential

The following nozzle types are commonly used for boom sprayer applications. The patterns are tapered, so they will not suffice as a single uniform pass. However, with proper overlap (about 30 percent on each edge) the patterns are very uniform.

#### Nozzle spray patterns

##### Adjustable Spray Pattern

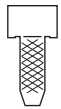

##### Tapered Spray Patterns

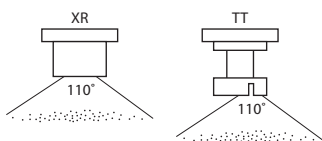

##### Drift Reducing

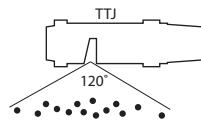

##### Drift Reducing-Venturi (tapered spray patterns)

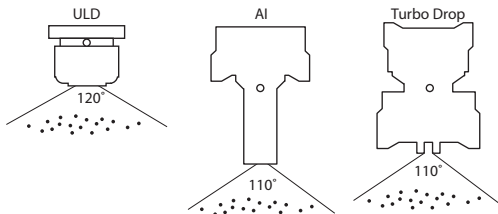

##### Even Spray Patterns

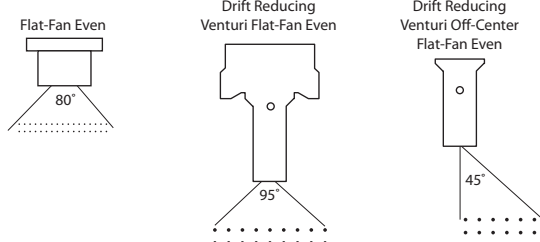

Some nozzle styles are available with even spray patterns (designated with the letter "E" in the number scheme — see item 10) and could be used in single-pass operations. Brass nozzles are not recommended. Nozzles constructed of plastic or stainless materials provide uniform flows and patterns for a longer period of use. Refer to K-State Research and Extension publication MF2541, *Nozzle Types for Boom Sprayer Applications of Crop Protection Products*, for a more detailed discussion of nozzle types.

Some basic nozzle designs recommended for use on handheld or backpack spray systems are the extended range flat-fan (XR, TR), turbo flat-fan (TT), drift reduction flat-fan (examples are ULD, AIC, and Turbo Drop), and turfjet (TTJ). Though the extended range and turbo flat-fan designs provide for a more uniform spray, they also could be more drift prone. Thus, adding the drift-reducing nozzle designs with larger droplets could be beneficial when drift is a concern. Most of these are available only in tapered edge patterns; however, some come as even spray, and a few come as off-center flat-spray patterns. Off-center flat-fan nozzles are typically available as even spray patterns. Off-center designs are best suited for spraying along fences, curbs, and guardrails.

Proper nozzle maintenance includes proper cleaning of the orifice. Use a soft-bristled brush for this purpose (item 9).

#### Additional information

Additional equations and illustrations on page 4 will help you determine ground speed and the square footage of areas of different shapes.

**Table 2.** Selected nozzle manufacturer websites.

Spraying Systems - TeeJet	<a href="http://www.teejet.com/">http://www.teejet.com/</a>
Greenleaf Technologies	<a href="http://www.turbodrop.com/">http://www.turbodrop.com/</a>
Hypro Pumps	<a href="http://www.hypropumps.com/">http://www.hypropumps.com/</a>
Wilger	<a href="http://www.wilger.net/">http://www.wilger.net/</a>
Hardi – North America	<a href="http://www.hardi-us.com/">http://www.hardi-us.com/</a>
Lechler	<a href="http://www.lechlerusa.com/">http://www.lechlerusa.com/</a>
CP Products	<a href="http://www.cproductsinc.com/">http://www.cproductsinc.com/</a>
ABJ Agri Products	<a href="http://www.abjagri.com/">http://www.abjagri.com/</a>

## Additional Equations

Use the following equation to determine ground speed:

$$\text{Speed (mph)} = \frac{\text{distance (feet)} \times 60}{\text{time (seconds)} \times 88}$$

1 mph = 88 feet per 60 seconds

Below are equations to help measure areas.

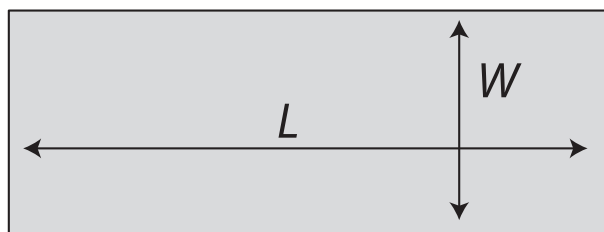

$$\text{Area} = \text{Length} \times \text{Width}$$

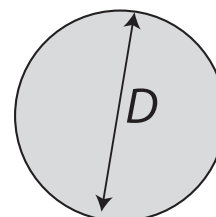

$$\text{Area} = \frac{\pi \times \text{Diameter}^2}{4}$$

$$\pi = 3.14159$$

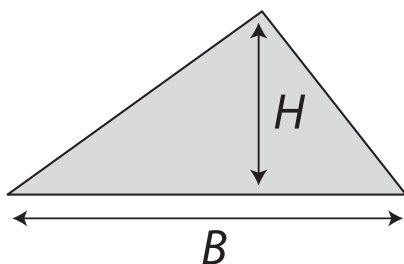

$$\text{Area} = \frac{\text{Base} \times \text{Height}}{2}$$

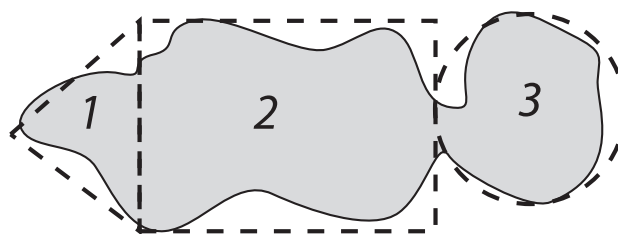

An irregularly shaped area can be divided into one or more geometric figures. Calculate the area of each figure and then combine for the total area.

## Acknowledgements

Contributions for this document were received from Dow AgroSciences.

Brand names appearing in this publication are for product identification purposes only. No endorsement is intended, nor is criticism implied of similar products not mentioned.

Publications from Kansas State University are available on the World Wide Web at: [www.ksre.ksu.edu](http://www.ksre.ksu.edu)

Publications are reviewed or revised annually by appropriate faculty to reflect current research and practice. Date shown is that of publication or last revision. Contents of this publication may be freely reproduced for educational purposes. All other rights reserved.

In each case, credit Robert E. Wolf, *Hand Sprayer Calibration Steps Worksheet*, Kansas State University, April 2010.

**Kansas State University Agricultural Experiment Station and Cooperative Extension Service**

MF2915

April 2010

K-State Research and Extension is an equal opportunity provider and employer. Issued in furtherance of Cooperative Extension Work, Acts of May 8 and June 30, 1914, as amended. Kansas State University, County Extension Councils, Extension Districts, and United States Department of Agriculture Cooperating, Gary Pierzynski, Interim Director.